

2507

25x25x7MM

General Specifications

- ◆ Material..... Frame: Plastic (UL94V-0)
Impeller: Plastic (UL94V-0)
Lead Wire: UL1571AWG#28 or Equivalent (+) Red, (-) Black
- ◆ Expected Life..... Ball Bearing 50,000hrs (40°C)
Sleeve Bearing 30,000hrs (40°C)
- ◆ Temperature Range.... Operating Temperature -10°C~70°C (Non-condensing)
Storage Temperature -40°C~70°C (Non-condensing)
- ◆ Safety Standards..... UL, TUV, RoHS, CE
- ◆ DC Fan Specials..... RD, FG, IP54



Specifications

Model	Rev	#Bearing Type	Rated Voltage	Operating Voltage	Input Current	Input Power	Speed	Max Air Flow		Max Static Pressure		Noise	Weight
Part No.	XXX	B	VDC	VDC	Amp	Watt	RPM	CFM	m ³ /min	Inch-H ₂ O	Pa	dB-A	g
DA02507#05U		B.S	5	3.5~5.5	0.20	1.00	14000	2.25	0.06	0.21	52.29	32.0	5.0
DA02507#05H		B.S	5	3.5~5.5	0.15	0.75	12000	1.97	0.05	0.16	39.03	30.0	5.0
DA02507#05M		B.S	5	3.5~5.5	0.12	0.60	10000	1.57	0.04	0.11	26.48	24.0	5.0
DA02507#05L		B.S	5	3.5~5.5	0.07	0.35	8000	1.15	0.03	0.07	16.38	21.0	5.0
DA02507#12U		B.S	12	7.0~13.8	0.09	1.08	14000	2.25	0.06	0.21	52.29	32.0	5.0
DA02507#12H		B.S	12	7.0~13.8	0.07	0.84	12000	1.97	0.05	0.16	39.03	30.0	5.0
DA02507#12M		B.S	12	7.0~13.8	0.05	0.60	10000	1.57	0.04	0.11	26.48	24.0	5.0
DA02507#12L		B.S	12	7.0~13.8	0.04	0.48	8000	1.15	0.03	0.07	16.38	21.0	5.0

All model could be customized on voltage or any other requirements to fit your need.

Dimensions (Unit:mm)

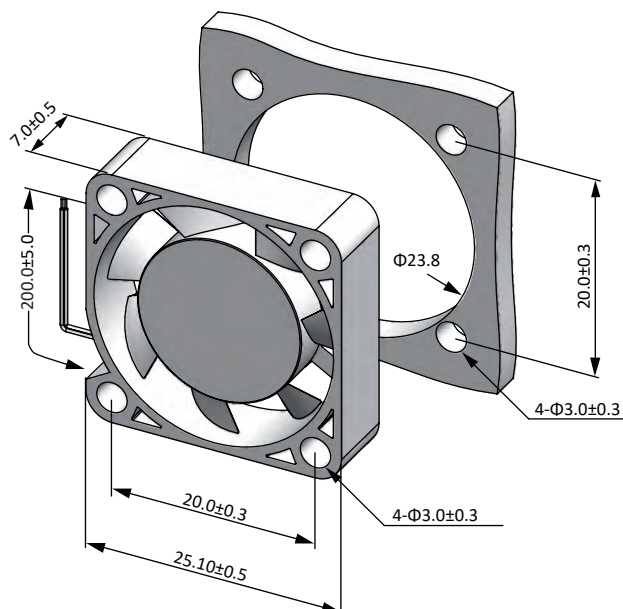

PQ Curve (At Rated Voltage)

